

USER'S MANUAL

DVR
Digital Video Recorder

Contents

Chapter 1: DVR Features	2
DVR Feature	2
Chapter 2: Overview	2
2.1 Front Panel	2
2.2 Rear Panel	3
2.3 Remote Control	5
Chapter 3: Installation	5
3.1 Install Hard Disk	5
3.2 Connecting Camera and Monitor	5
3.3 VGA Output (optional).....	5
3.4 Connecting Power Supply	5
Chapter 4: Starting the DVR	5
4.1 Firmware Version	5
4.2 Detecting Installed Hard Drive.....	6
4.3 Format Hard Drive	6
Chapter 5: DVR Menu System	6
5.1 Navigating the Menus	6
5.2 Menu Overview	7
5.3 Camera Setup	7
5.4 Record Setup	7
5.5 Record Frame Rate.....	8
5.6 Video Quality	8
5.7 Record Schedule.....	8
5.8 Sensor Setup	9
5.9 H/W Sensor Setup	9
5.10 Motion Detector Setup	10
5.11 Hard Drive Setup.....	10
5.12 Miscellaneous Setup - Change Password.....	11
5.13 Miscellaneous Setup - Set Time	11
5.14 Miscellaneous Setup - Hidden Channel	11
5.15 Miscellaneous Setup - Audio Port Setup.....	12
5.16 Miscellaneous Setup - PTZ Setup	12
5.17 Miscellaneous Setup - Image Parameters.....	12
5.18 Miscellaneous Setup - Password Enable	13
5.19 Miscellaneous Setup - Keypad Tones.....	13
5.20 Miscellaneous Setup - Sequence Dwell Time	13
5.21 Miscellaneous Setup - VGA Setup	14
5.22 Network Setup.....	14
5.23 Language	18
5.24 Video Backup	18
5.25 Reset Menu.....	20
5.26 NTSC/PAL Output select	20
Chapter 6: Record	20
6.1 Start Recording.....	20
6.2 Audio Recording	21

6.3 Stop Recording21

6.4 Estimated Recording Length21

Chapter 7: Playback.....21

Chapter 8: USB Programming.....22

8.1 Driver Installation:22

8.2 Program Interface – Button Functions:23

8.3 Program Running23

8.3.1 HDD play mode23

8.3.2 FILE play mode25

8.3.3 NET play mode25

Chapter 9: Specification26

Chapter 10: Appendix.....27

10.1 System connection diagram.....27

10.2 Accessories27

Chapter 1: DVR Features

DVR Feature

- MPEG-4 compression
- **4-Channel:** 4 BNC Camera Inputs - 2 BNC Video Outputs
9-Channel: 9 BNC Camera Inputs - 1 BNC Video Output
- **4-Channel:** 2 Audio Inputs - 2 Audio Outputs
9-Channel: 1 Audio Input -1 Audio Output
- System Format : NTSC /PAL
- Motion Detection with Sensitivity and Area Settings
- Time Schedule, Alarm and Motion Triggered Recording Modes
- Hard Disk Support up to 500GB
- Supports PTZ Control via RS-485 Port
- View and Operate over Network (Broadband Connection Required)
- Built-in USB 2.0 Port for Backup to Computer or USB Memory Stick Backup (Optional)
- VGA Output (Optional)

Chapter 2: Overview

2.1 Front Panel

2.1.1 4-ch DVR front panel

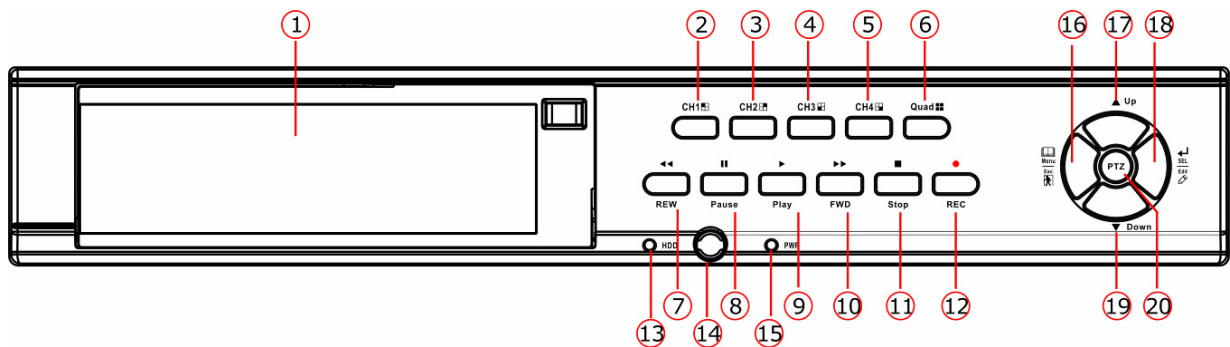

- | | |
|---|---|
| <ol style="list-style-type: none"> 1. Removable HDD Tray 2. CH1 3. CH2 4. CH3 5. CH4 | <ol style="list-style-type: none"> 6. QUAD: View all channels 7. REW: Rewind play/Focus 8. PAUSE: Pause/Auto sequence display 9. PLAY: Play recorded file/Zoom 10. FWD : Forward play/Iris |
|---|---|

- 11. STOP
- 12. REC
- 13. HDD LED
- 14. IR Receiver
- 15. Power LED

- 16. MENU/ESC/LEFT
- 17. UP
- 18. SEL/EDIT/RIGHT
- 19. DOWN
- 20. PTZ: Enter PTZ mode

2.1.2 9-ch DVR front panel

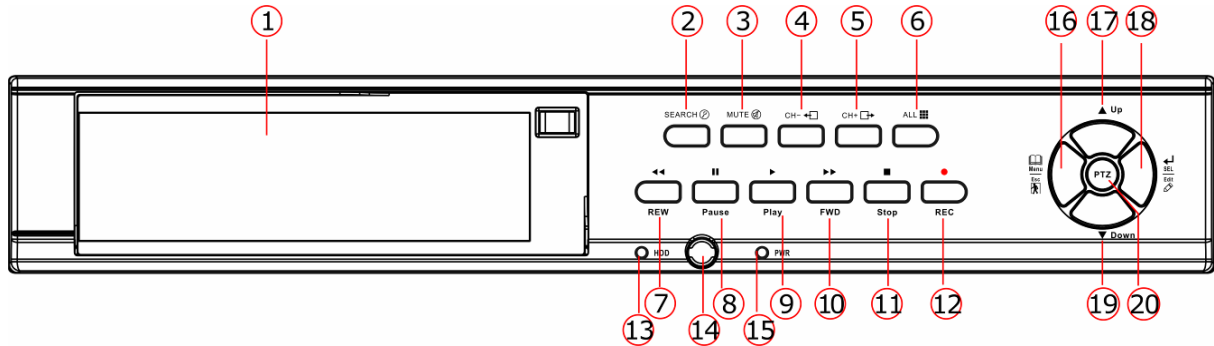

- 1. Removable HDD Tray
- 2. SEARCH
- 3. MUTE: Turn on/off audio output
- 4. CH-: View previous channel
- 5. CH+: View next channel
- 6. ALL: View all channels
- 7. REW: Rewind play/Focus
- 8. PAUSE: Pause/Auto sequence display
- 9. PLAY: Play recorded file/Zoom
- 10. FWD : Forward play/Iris

- 11. STOP
- 12. REC: Record
- 13. HDD LED
- 14. IR receiver
- 15. Power LED
- 16. MENU/ESC/LEFT
- 17. UP
- 18. SEL/EDIT/RIGHT
- 19. DOWN
- 20. PTZ: Enter PTZ mode

2.2 Rear Panel

2.2.1 4-ch DVR rear panel

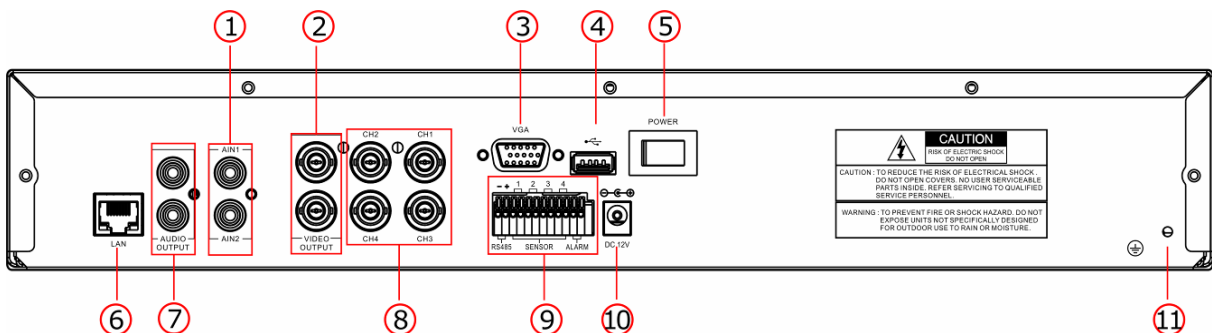

1. Audio inputs
2. Video outputs
3. VGA output (Optional)
4. USB port
5. POWER Switch
6. LAN: Ethernet port
7. Audio outputs
8. CH1-CH4 : Video input1- video input4
9. RS-485/SENSOR/ALARM
10. DC Power Input Jack
11. Grounding

2.2.2 9-ch DVR rear panel

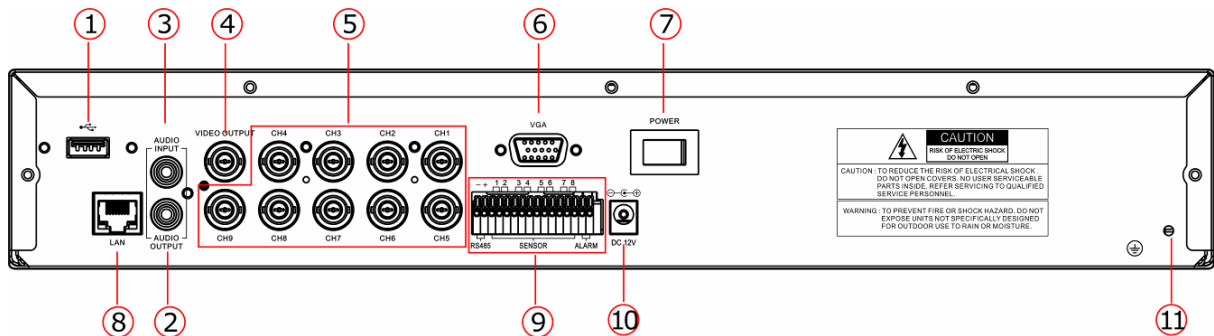

1. USB port
2. Audio output
3. Audio input
4. Video output
5. CH1-CH9 : Video input1- video input9
6. VGA output (Optional)
7. POWER Switch
8. LAN: Ethernet port
9. RS-485/Sensor/Alarm
10. DC Power input jack
11. Grounding

2.3 Remote Control



1-9	Channel Select 1-4/9
0	Number
ALL	Display all Channels
Menu	Enter or Exit Menu
▲	Move Up
▼	Move Down
◀ / ▶	Left/ Right
SEL	Select /Modify Item
◀◀	Rewind/Focus
▶	Play Recording/Zoom
▶▶	Fast Forward/Iris
●	Record
	Pause/Auto sequence display
■	Stop Recording/Playback
Audio/Search	Search (9-ch)or switch the audio channels(4-ch)
Mute	Turn on/off audio output

Chapter 3: Installation

3.1 Install Hard Disk

NOTICE: Don't take out HDD when DVR is running.

- (1) Take out the Hard Disk Drive tray carefully.
- (2) Connect the power cord and data cable to hard disk carefully.
- (3) Put the Hard Disk Drive tray back into the DVR and then lock the HDD tray.

3.2 Connecting Camera and Monitor

There are 4/9 camera inputs and 2/1 Monitor outputs with BNC connectors (Refer to 2.2 Rear Panel).

3.3 VGA Output (optional)

There is 1 CRT or LCD monitor output with VGA port.

3.4 Connecting Power Supply

Please only use the power adapter supplied with the DVR.

Chapter 4: Starting the DVR

4.1 Firmware Version



After connecting the power adapter and turning on the power button, the system will boot-up and display the version and released date of the DVR

4.2 Detecting Installed Hard Drive

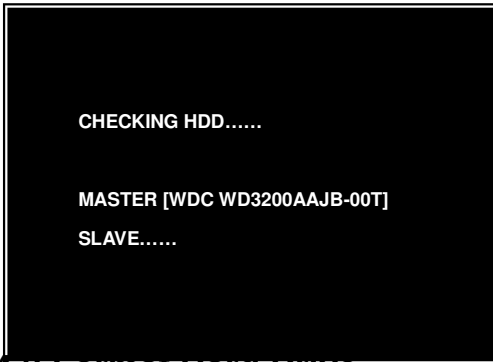

DVR will detect the installed hard drive and display the hard drive information.

4.3 Format Hard Drive

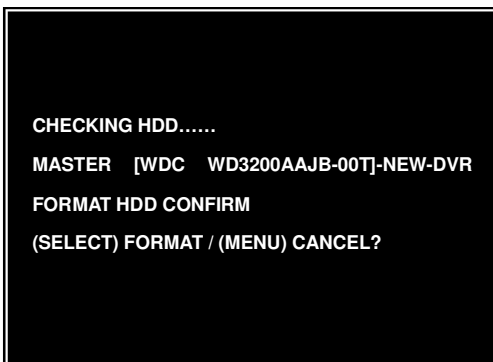

When the DVR detects a new hard drive, you will be prompted to format the hard drive before using the DVR.

Press **[SEL]** to format or press **[MENU]** to cancel.

Chapter 5: DVR Menu System

5.1 Navigating the Menus

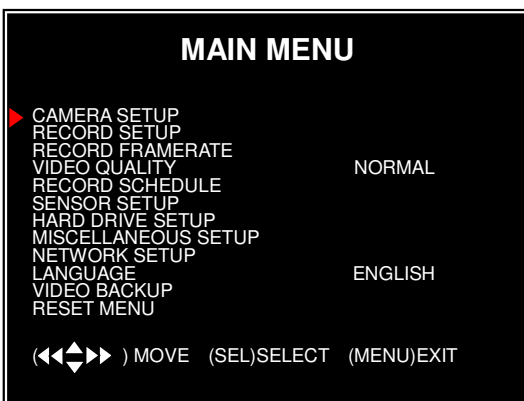

Press **[MENU]** to enter Main Menu

Press **[▲, ▼, ◀▶]** to move the cursor

Press **[SEL]** to select/modify settings

Press **[MENU]** again to exit or go back to previous menu.

5.2 Menu Overview

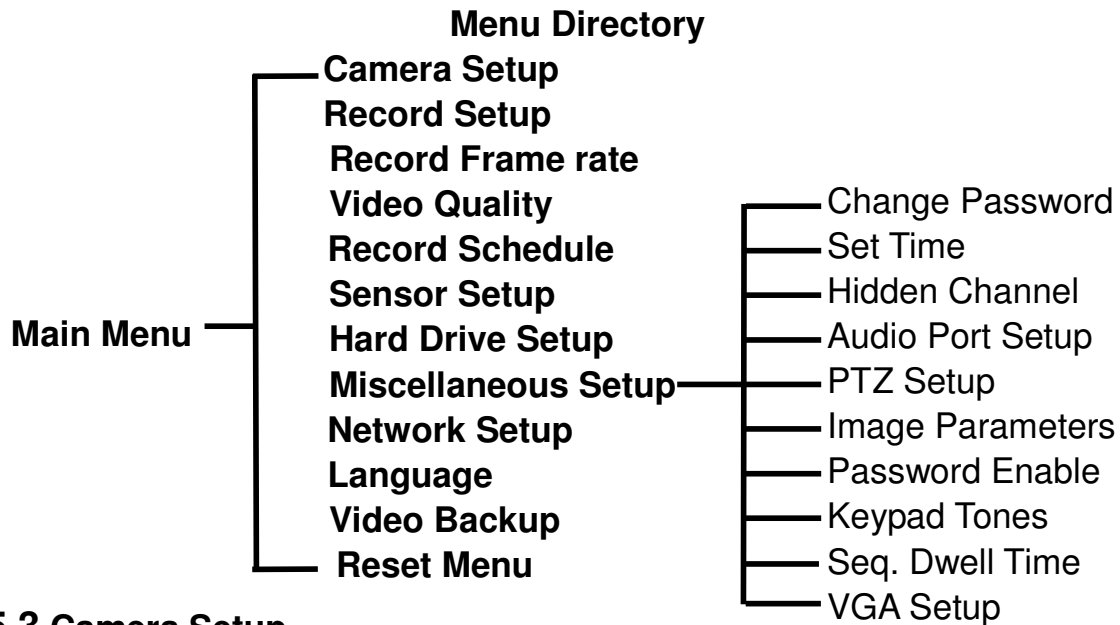

5.3 Camera Setup

1 ▶ ON CAMERA	2 ON SETUP
3 ON	4 ON
(◀◀▶▶)MOVE (SEL)	SELECT (MENU)EXIT

Camera Setup allows you to turn cameras on or off.

Press [**▲**, **▼**, **◀◀** and **▶▶**] buttons to select a channel and then press [**SEL**] to modify the setting **ON** or **OFF**.

Note : If a camera channel is set to OFF, it will not be recorded (Refer to 6.4 Record Setup)

5.4 Record Setup

1 ON RECORD	2 ▶ NOCAM SETUP
3 ON	4 ON
(◀◀▶▶)MOVE (SEL)	SELECT (MENU)EXIT

Record Setup allows you to set up recording channels.

Press [**▲**, **▼**, **◀◀** and **▶▶**] buttons to select a channel, and then press [**SEL**] to modify the setting to **ON** or **OFF**.

If a channel is disabled in Camera Setup, it will not record and the DVR will display “NOCAM” on screen.

5.5 Record Frame Rate

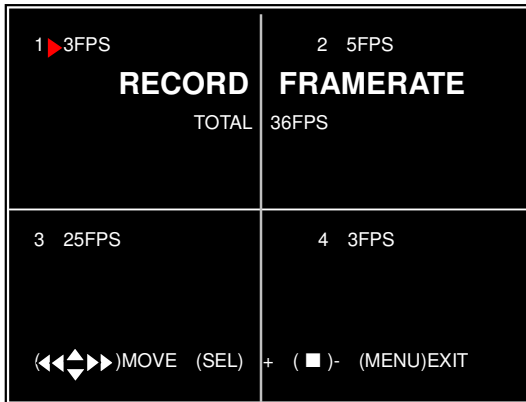

The total frame rate is 50fps (PAL) or 60fps (NTSC). You can set the frame rate for the channel which you select to record. If the sum of the frame rate you select for all cameras is more than 50fps (PAL)/60fps(NTSC), the DVR will automatically adjust the largest frame rate value to a smaller value.

Press [**▲**, **▼**, **◀◀** or **▶▶**] button to select a channel, and then press [**SEL**] to increase the value or press [**■STOP**] to reduce the value.

Note: Higher frame rate shows smooth images, but requires more hard drive space.

5.6 Video Quality

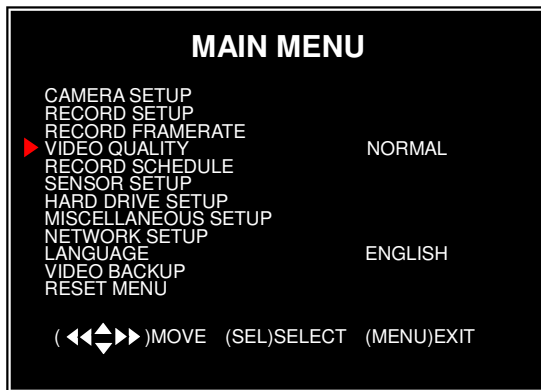

Video Quality has 4 different settings: **Highest, High, Normal and Low.**

The higher the video quality, the better quality of images, however higher quality images require more hard drive space.

Press [**SEL**] to change the quality setting.

5.7 Record Schedule

Setting the Record Schedule allows you to customize the type of recording depending on the time of day.

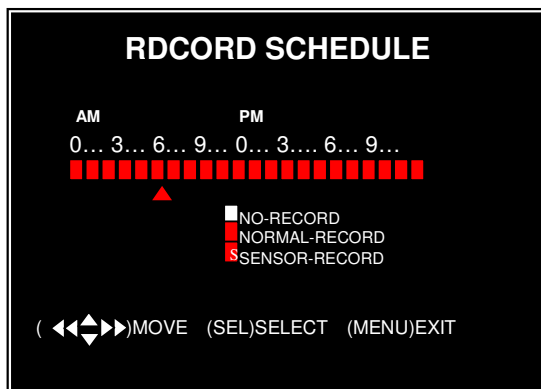

The time line indicates 24 hours of a day based on AM/PM (0 = 12).

Press [**▲**, **▼**, **◀◀** or **▶▶**] button to select a time point, press [**SEL**] to modify the recording mode.

NO-RECORD [□white]: DVR will not record during the time.

NORMAL-RECORD [red]: DVR will record continuously.

SENSOR-RECORD [S]: DVR will record when sensor or motion is triggered.

NOTE: In order to activate the record schedule, press the [●] record button when viewing the cameras. After pressing the [●] record button, if schedule is set to “NORMAL-RECORD” , the DVR will start to record immediately; if the schedule is set to be “SENSOR-RECORD” , the DVR will not start recording until a motion is detected by the DVR or an installed sensor is triggered.

5.8 Sensor Setup

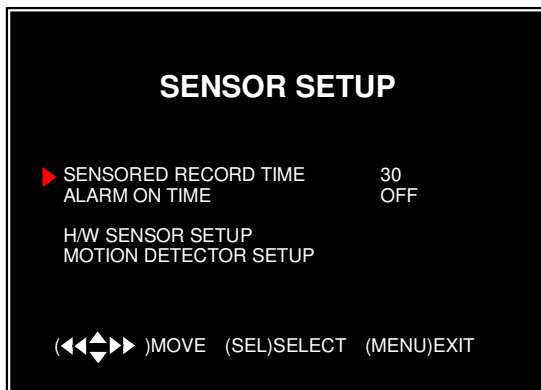

Sensored Record Time indicates how long the recording time is when the motion or sensor is triggered.

Alarm On Time indicates whether the buzzer will sound when motion is detected.

CONT: Continuous alarm until any key is pressed.

OFF: No alarm

Note: Sensored Record Time and Alarm On Time are measured in seconds

5.9 H/W Sensor Setup

Note: Sensors and extension alarm are not included with the DVR system and may be purchased separately.

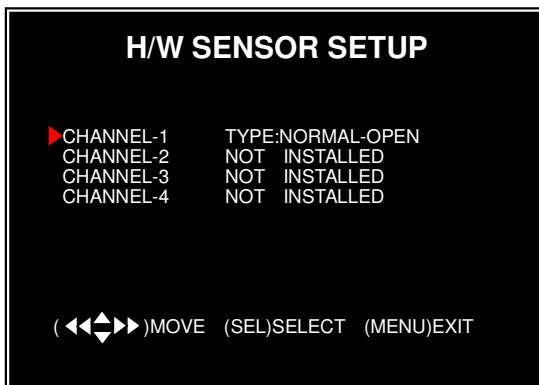

Hardware Sensor Setup:

There are 3 different modes for sensor setting: NOT INSTALLED, NORMAL-CLOSE and NORMAL-OPEN. Consult the alarm purchased for more details on which setting is required.

Note: For 4-ch DVR, there are 4CH inputs of the sensor
 For 9-ch DVR, there are 8CH inputs of the sensor

5.10 Motion Detector Setup

This section allows you to set up motion detection options for each camera.

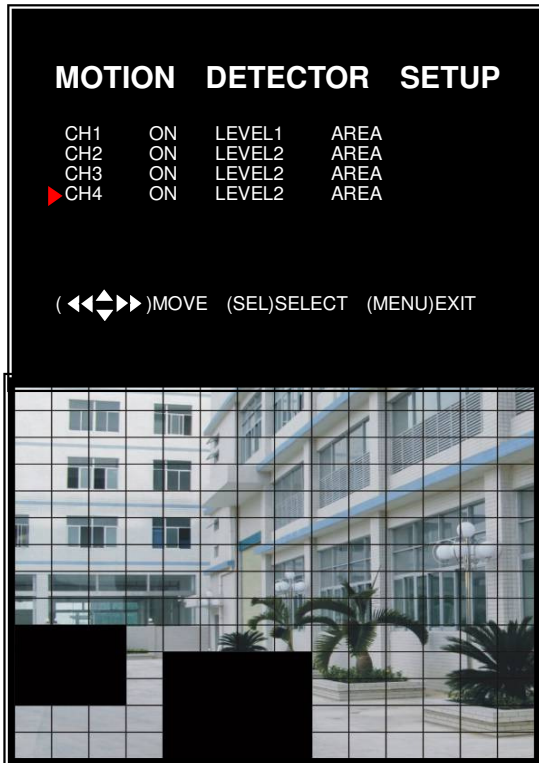

Motion Detector Setup:

ON/OFF: Enable or disable motion detection recording.

LEVEL: Sensitivity for motion detection. There are 3 levels sensitivity: Level 1-low, level 3- highest

AREA: Select detectable area on the screen.

Area Selection:

Press [▲, ▼, ◀◀ or ▶▶] button to select a block, and press [SEL] button to set the block to detect motion. The area is detectable when it is clear, the area is not detectable when it is covert by shadow.

Press “Stop” button to disable all areas, press “Quad” or “ALL” button to enable all areas.

5.11 Hard Drive Setup

This section will display the current hard drive status and usage options

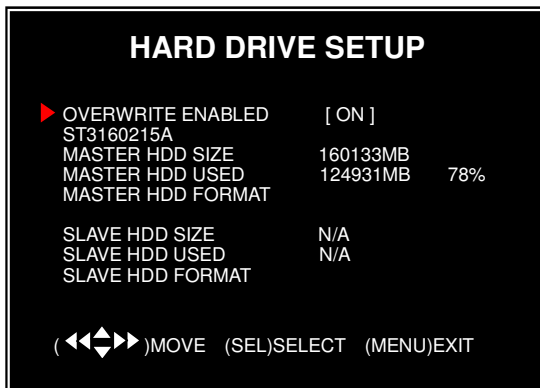

Overwrite Enabled:

ON: Overwrite oldest video when hard drive is full.

OFF: Stop recording when hard drive is full.

HDD SIZE: Indicates the total capacity of the hard drive installed in the DVR.

HDD USED: Indicates the space used in the hard disk drive for recording and the percent used.

HDD FORMAT: Will erase all video and data on the installed hard drive and make it readable by

the DVR

Note: You will be prompted for the password when formatting a hard drive. The default password is “111111”

5.12 Miscellaneous Setup - Change Password

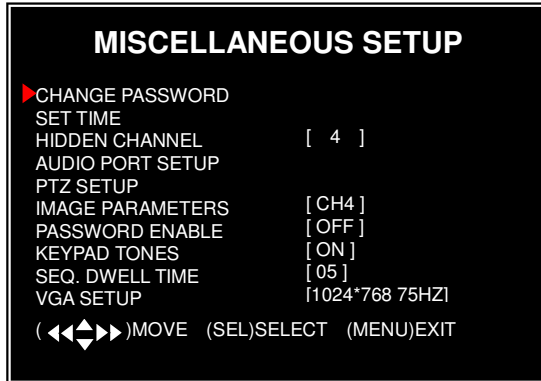

This option allows you to change the system password. The password must be composed with six characters.

All keys can be used as password key **except** the [MENU] key, which is used to exit.

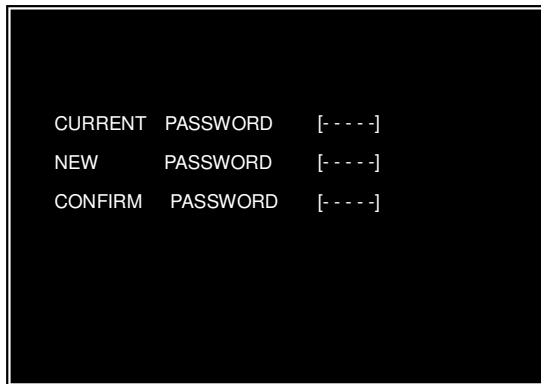

Enter the current password first, and then enter six characters as your new password, repeat the new password to confirm.

If you forget your password, please contact technical support for assistance.

5.13 Miscellaneous Setup - Set Time



The system date and time format is YYYY/MM/DD and HH:MM: SS.

Press [<< >>] button to select the data to modify, press [SEL] to modify. Press [MENU] to save and return to previous menu.

5.14 Miscellaneous Setup - Hidden Channel

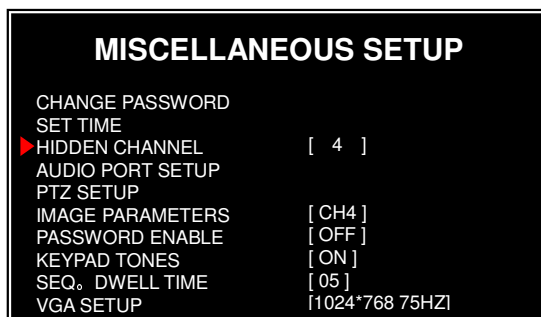

The system provides a function to hide a channel in monitoring mode. The selected channel can still be recorded while it's hidden; the hidden picture is viewable during playing back.

Press [SEL] to select a channel to hide.

5.15 Miscellaneous Setup - Audio Port Setup

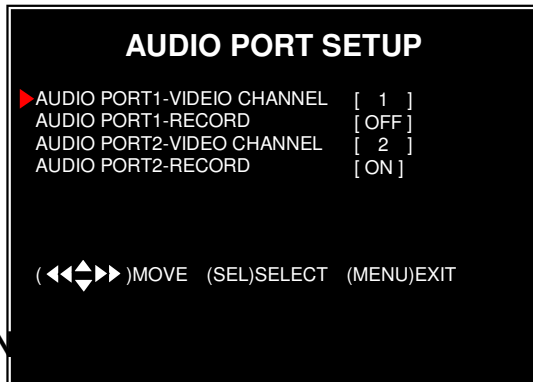

You can select the audio recording function to **ON** or **OFF**, and select the video channel that you like to record the audio on.

Note: For 9-ch DVR, there is only 1 audio input.

5.16 Miscellaneous Setup - PTZ Setup

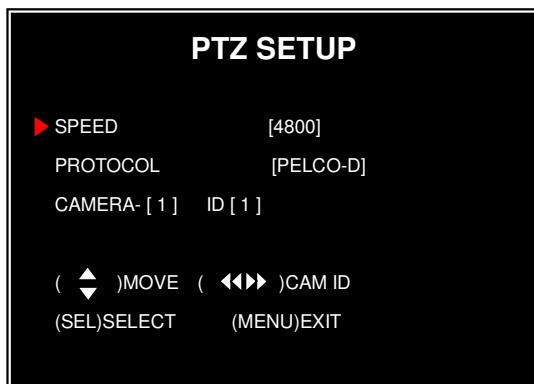

SPEED: Set the baud rate (2400,4800 ,9600 ,19200 , 38400) to match your speed dome.

PROTOCOL: Supports “PELCO-D” and “PELCO-P”. Select the protocol according to your speed dome’s protocol.

CAMERA: Select the camera channel which is connected with the speed dome.

ID: Assign an ID to your speed dome.

Press [**SEL**] to select the camera, press [<<] and [>>] buttons to assign the ID.

Note: the ID must be unique.

5.17 Miscellaneous Setup - Image Parameters

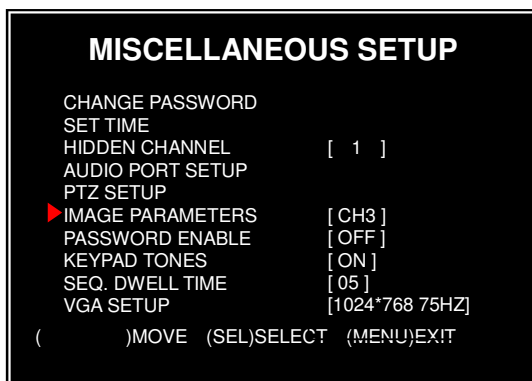

You can adjust the image parameters according to your needs.

Move the cursor to this selection and press [<<<] or [>>>] button to select a channel you want to adjust, then press [**SEL**] button to edit parameters.



CON: Contrast

BRI: Brightness

HUE: Hue

SAT: Saturation

Press [▲] or [▼] to select the item , and then press [◀◀] and [▶▶] buttons to adjust the value.

5.18 Miscellaneous Setup - Password Enable

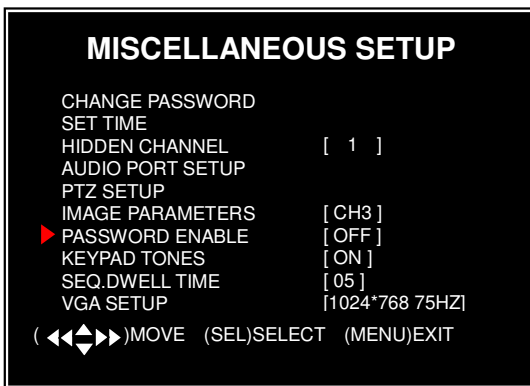

The password will be required to control the DVR when this option is set to “**ON**”, and the password is not required when this option is set to “**OFF**”.

5.19 Miscellaneous Setup - Keypad Tones

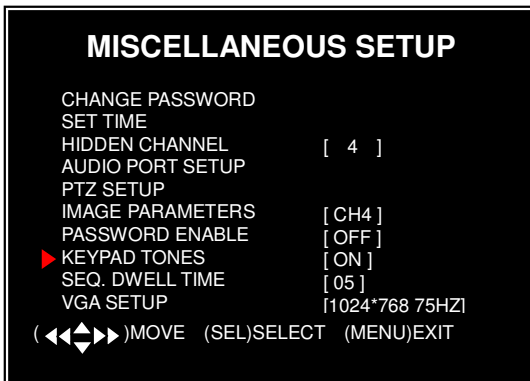

This function allows you to enable /disable buzzer sound when pressing a button. Press [SEL] to select **ON** or **OFF**.

5.20 Miscellaneous Setup - Sequence Dwell Time

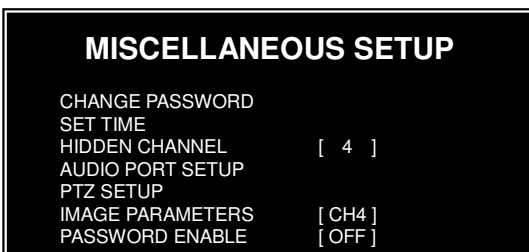

This function allows you to set the dwell time for each camera when you enable the auto sequence display function.

Press [◀◀] and [▶▶] buttons to adjust the value

After setting, press [**II**] button to turn on auto-sequence display function and then there's a "SEQ" symbol displayed on the right top of screen. Press [**II**] again to turn off this function in preview mode

5.21 Miscellaneous Setup - VGA Setup

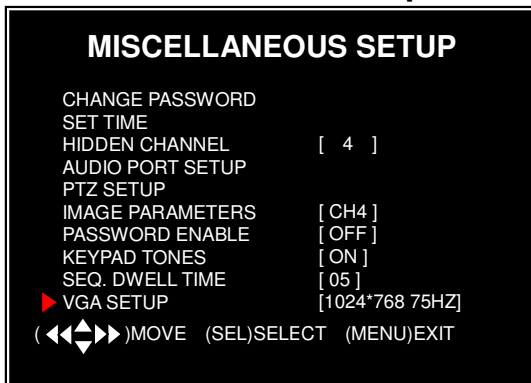

Select a VGA resolution to match your CRT or LCD monitor.

NOTE: VGA video output is an optional function and may not be available on all models.

5.22 Network Setup

Network Setup allows you to prepare the DVR for viewing over the internet or local network.

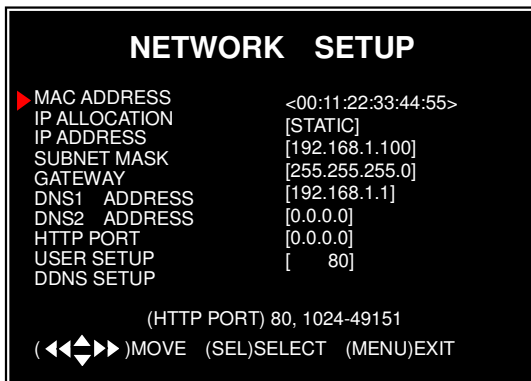

MAC ADDRESS: In a local area network(LAN) , the MAC (Media Access Control) address is your computer's unique hardware identity code(On an Ethernet LAN , it is the same as your Ethernet address).When you are connected to the Internet from your computer (or host as the Internet protocol thinks of it) , a corresponding table relates

IMPORTANT: This setting should only be changed if multiple DVRs are being setup on the same network and the first code “00” must not to be changed.

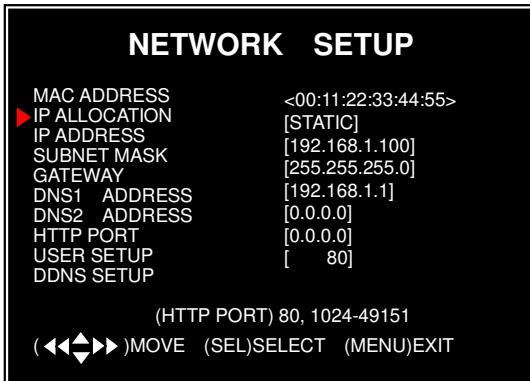

IP ALLOCATION: DVR supports DHCP and Static IP modes. If your modem/router supports DHCP function, you can use DHCP mode. When using STATIC mode, you will be required to setup your IP settings manually.

Note: After setting the DVR to DHCP mode restart the unit.

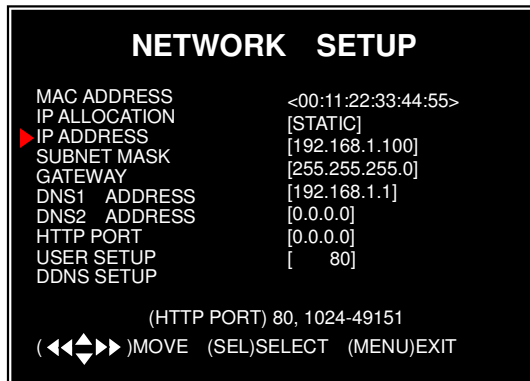

IP Address: In a local network, the IP address is a unique designated address for your DVR recognized by your router. Ensure this number is within the range usable by your modem/router. Use the UP “▲” and DOWN “▼” buttons to move the cursor and use the “SELECT” button to change the numbers. Once you have finished the changes restart your DVR.

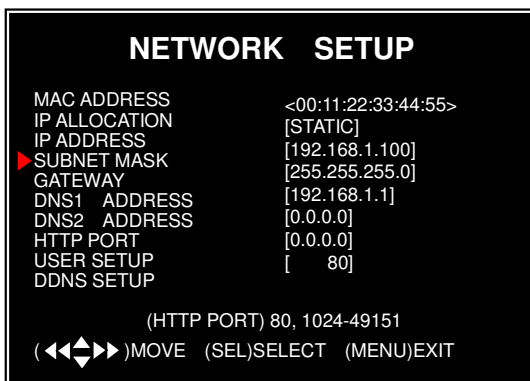

SUBNET MASK: Subnet Mask is used to determine what subnet an IP address belongs to. A number that is used to identify a sub network so that IP addresses can be recognized on a local area network. Consult your modem/router for your LAN’s subnet mask.

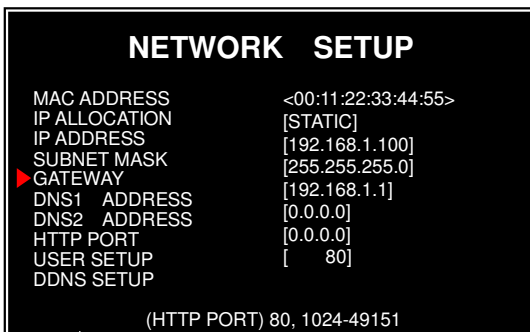

GATEWAY: Set this number to the gateway set by your modem/router.

NOTE: To adjust the IP ADDRESS , SUBNET MASK and GATEWAY value, only when the [STATIC] mode is being selected.

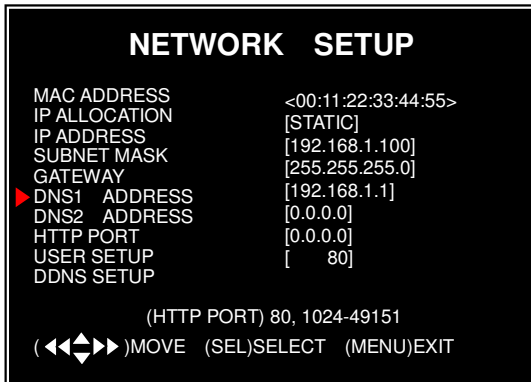

DNS ADDRESS: This code should be provided by your local ISP.

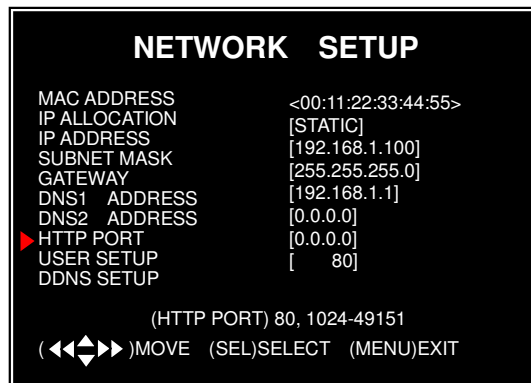

HTTP PORT: This port number is used to communicate with PC Client. The default value is 80(Can be changed from 1024 to 49151)

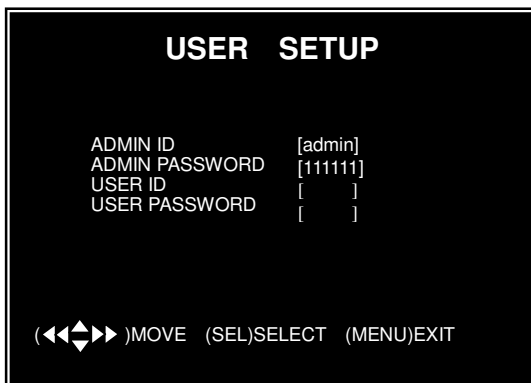

USER SETUP: When accessing the DVR from a remote location you will be prompted for a login and password. The default is “admin” for full administrator rights. Set “User ID” and password to setup a user with limited rights to prevent tampering.

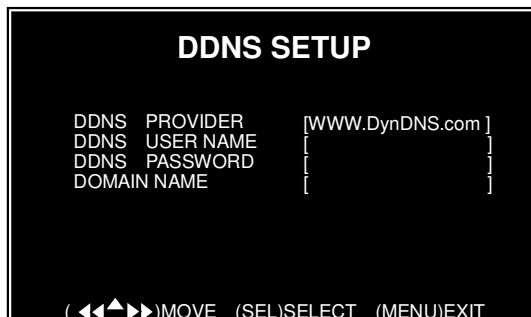

DDNS SETUP : If you require an external service to maintain a dynamic IP address enter the user information here

LAN-DVR Connection

See the diagram below for steps to connect your DVR to a local area network or the internet. For remote monitoring from your computer, you must have a LAN connection available or broadband Internet access.

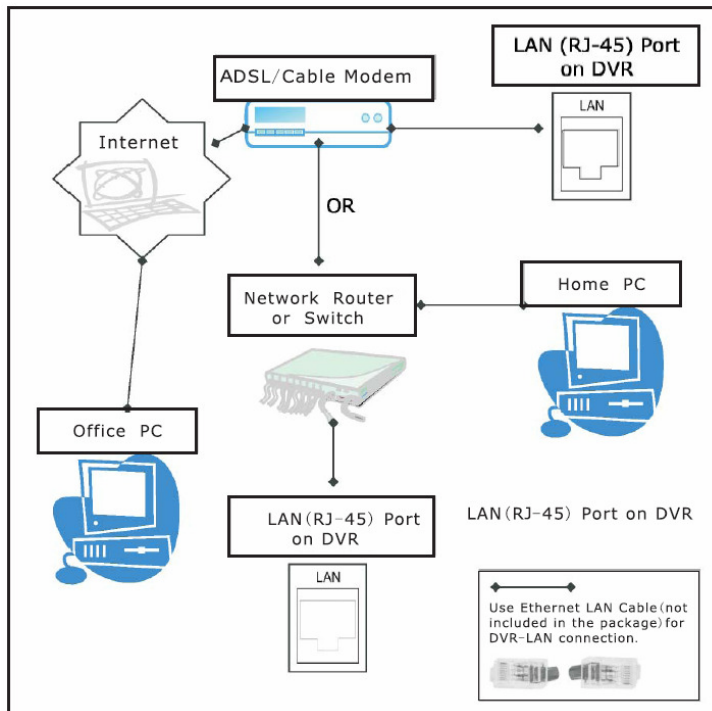

You need to register a www.dyndns.com to get a free account. After registration, you will have a username and password. You can also register your domain name on the website. Please refer to Chapter 5 “Network Setup” for more details. There you will learn how to input the Dyndns username, password, and domain name. You can log in from anywhere by using Internet Explorer and entering your DVR’s domain name.

5.23 Language

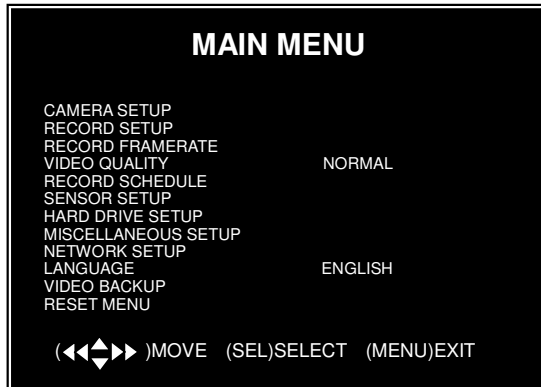

You can change the OSD language from the default English to other languages, if your DVR supports multi-languages.

5.24 Video Backup

This function is only available for the model which supports USB memory stick or CD-RW device backup. If your DVR is with PC-link USB interface, please refer *Chapter 8* for video backup.



Move the cursor to “VIEW EVENTS”, press [SEL] to enter event list. Press [▲] or [▼] button to move the cursor, and then press [SEL] to select the event you like to backup and return to previous menu.



The DVR system already indicated the start & end time of the recording event. Move the cursor to “SIZE”, DVR will automatically indicate the size of the video you like to backup to USB memory stick or CD/DVD.

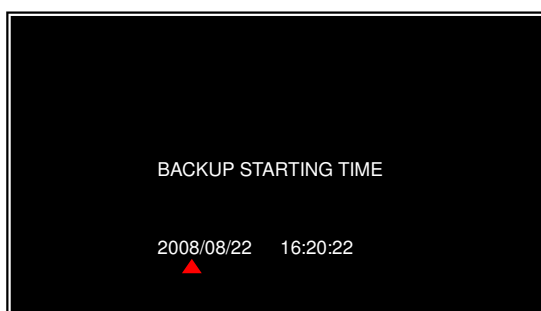

You can directly select the start& end time of a recording video to backup. Move the cursor to “START” or “END”; press [SEL] to enter the interface. Press [◀◀] or [▶▶] button to move the cursor, and then press [SEL] to modify the value.

Press [MENU] back to previous menu.

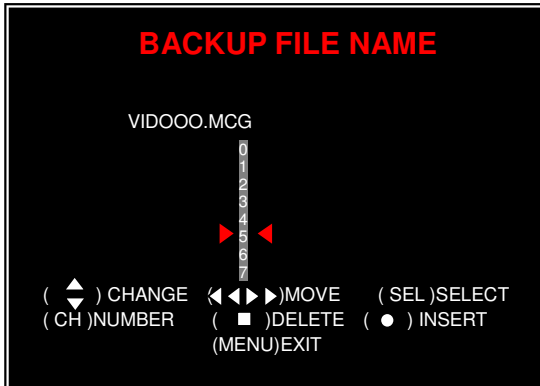

You can rename the backup file. Press [**◀◀**] or [**▶▶**] button to select the character you want to modify, press [**▲**] or [**▼**] button to select a character from the given character list, and then press [**SEL**] to enter.

Please note that the name must be ended with “.MCG”.



Insert your USB memory stick device into DVR’s USB port.

Move the cursor to “**BACKUP TO USB DEVICE**”, press [**SEL**] button.



DVR will check your USB device as left picture showed and then start to copy the backup file.

Please read *Charter 8* on how to play back your backup file.

5.25 Reset Menu

If you select this item, the system will restore all your settings to factory default values. You need to enter your password to reset the menu.

5.26 NTSC/PAL Output select

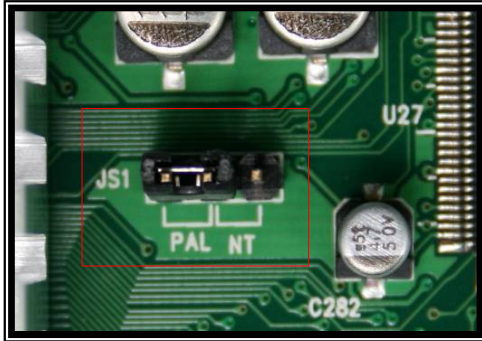

Change the jumper JS1 to select NTSC or PAL video output format according to the silkscreen on the PCB.

Chapter 6: Record

6.1 Start Recording

Press [●] record button to start recording according to the record schedule you have set. System will display some information on screen.



[●]: the red pot next to the channel name indicates that the channel is being recorded.

[A-REC]: indicates the current record schedule is set to NORMAL-RECORD mode.

[S-REC]: indicates the current record schedule is set to SENSOR-RECORD mode.

[N-REC]: indicates the current record schedule is set to NO-RECORD mode.

[39%]: indicates the percentage of hard disk space used.

[M]: HDD info ([M] Master Hard Disk)

6.2 Audio Recording

[🔊]: indicates this video channel is bundled with an audio port, and the audio output is on.

[🔇]: indicates the audio output is off.

[🔊]: indicates the audio is being recorded and the audio output is on.

For 9-channel, you could press [MUTE] button on front panel to be mute mode for audio output. The audio input can be still recorded while the output is mute.

For 4-channel, you could press [DOWN] button on front panel to be mute mode for audio output. The audio input can be still recorded while the output is mute. And you could press [UP] button to switch one of the two audio inputs to live output

6.3 Stop Recording

Press [■] stop button will stop recording. If password protection function is enabled, system will prompt you to input password. Only correct password can stop recording process.

6.4 Estimated Recording Length

Estimated record time based on 160GB HDD

Standard	Quality	60fps	48fps	32fps	16fps	1fps
NTSC	Highest	62	78	116	232	3720
	High	88	110	165	330	5280
	Normal	107	134	201	401	6420
	Lower	120	150	225	450	7200

Standard	Quality	50fps	36fps	24fps	12fps	1fps
PAL	Highest	64	89	133	267	3200
	High	90	125	188	375	4500
	Normal	110	153	229	458	5500
	Lower	123	171	256	513	6150

Unit: Hour

Chapter 7: Playback

In preview mode, pressing the [▶] PLAY button goes into PLAYBACK mode. The newest record event will be played.



Press the [MENU] button during in
21 PLAYBACK mode , then the system will list all
the recorded events. The latest record will be on
top of the list. Press the [▲] or [▼] button to

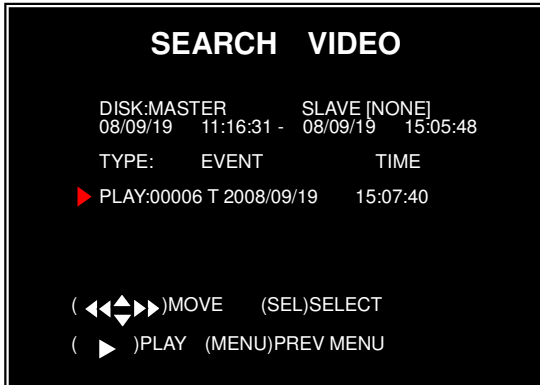

Another way to search video is directly input time period. Press the [MENU] button then use [◀◀] or [▶▶] button to select the TIME search mode. Use [SEL] button to edit time value, press [▶] to play the video. If the time you selected has no record event, it will indicates “NO EVENTS” on the screen when you press [▶] play button.

Chapter 8: USB Programming

8.1 Driver Installation:



- (1) Insert driver CD in your CD-ROM Drive.
- (2) Open CD directory.
- (3) Double click on the install applications.
- (4) Run “Install” program.
- (5) Follow the setup wizard to finish the installation.

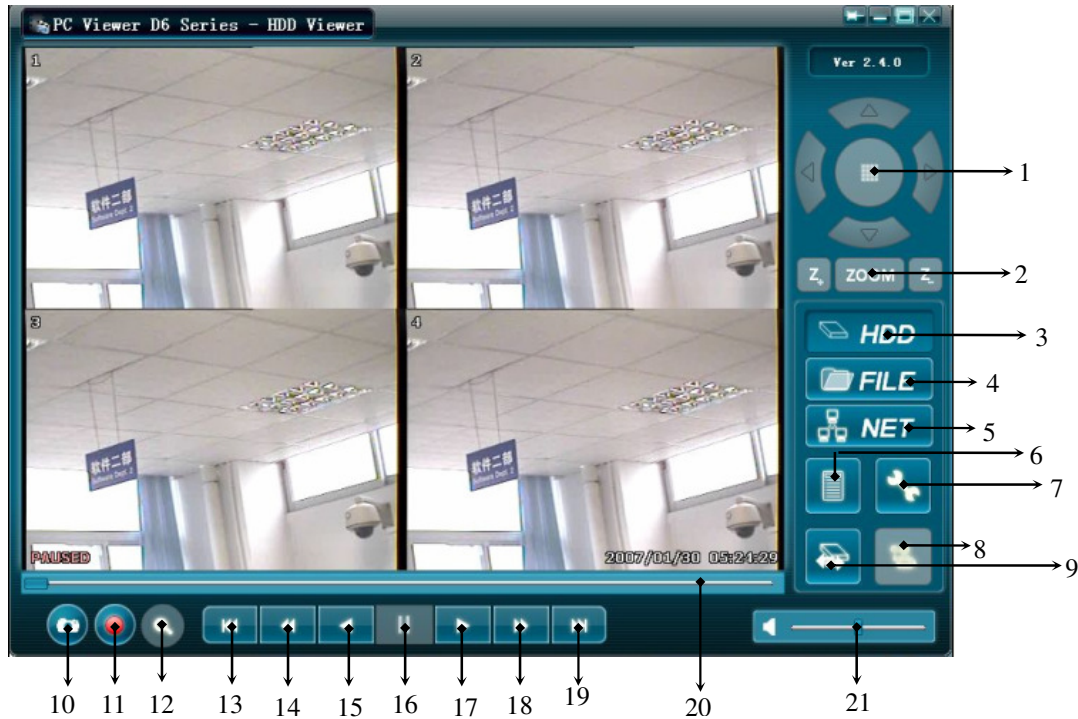

8.2 Program Interface – Button Functions:



1.PTZ Control	12. Time Search
	13. Jump back 60s
3.HDD Play Mode	14. Jump back 10s
4.File Play Mode	15. Reverse playback
5.Net Play Mode	16. Pause
6.Event List	17. forward playback
7.Change DVR settings	18. Jump forward 10s
8.Remote DVR Control	19. Jump forward 60s
9.Change Storage Device	20.Playback Slider
10.Capture Image	21.Audio Slider
11. Convert Streams to AVI file	

8.3 Program Running

8.3.1 HDD play mode

System will detect the HDD automatically when you connect the USB cable to your PC. An USB icon“  ” will appear in the system tray (right bottom corner of the screen). After you’ve seen the USB icon, double click “  ” icon on your desktop to run the program.

Note: if you do not follow above steps, the program will fail to detect HDD

Press “  ” to open the video event lists.

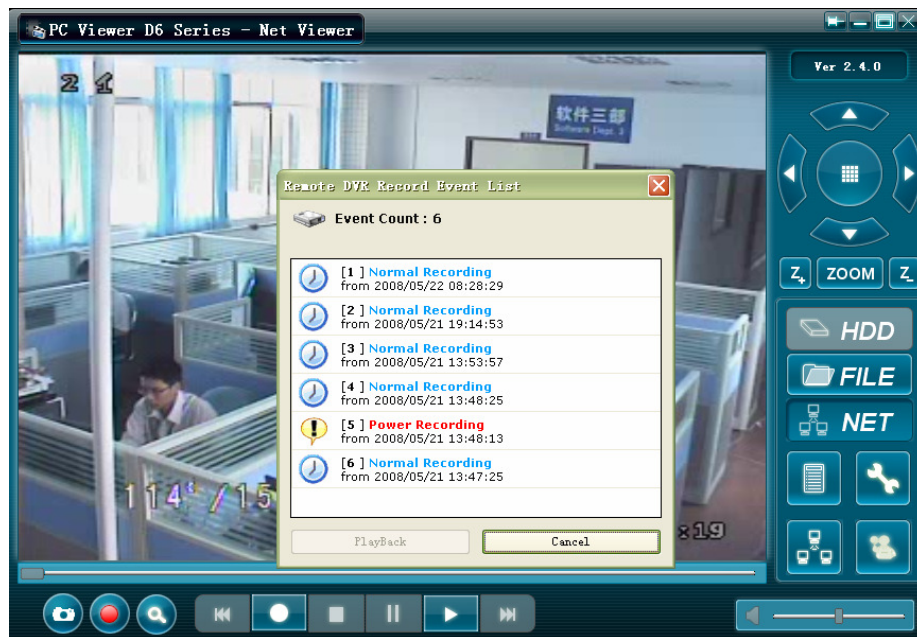

Press “” to configure the program local settings.

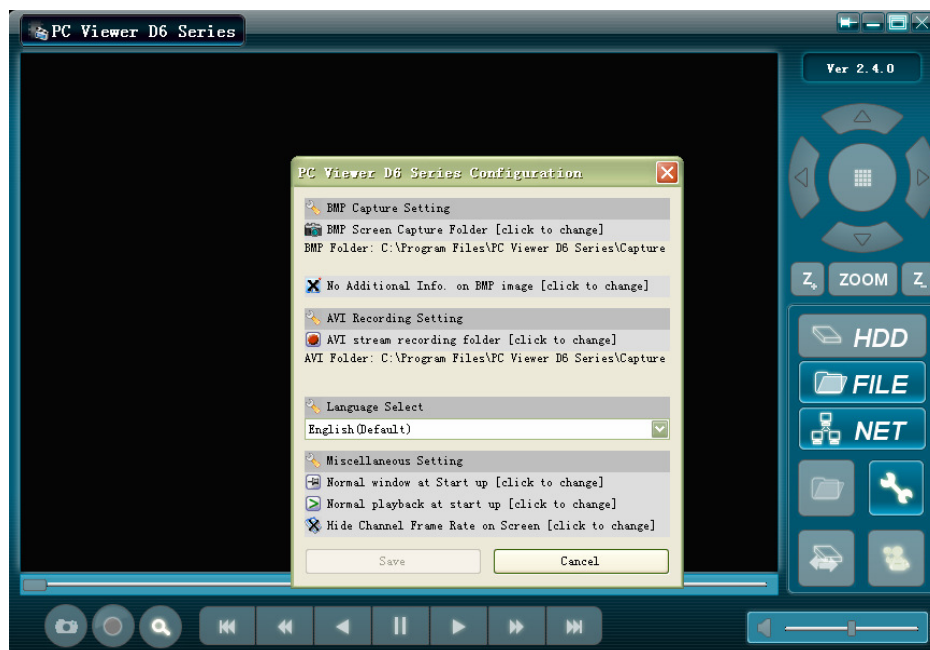

Press “” to play video.



8.3.2 FILE play mode

Press “ FILE” to open a folder and select the file you want play. Double click the file.
Note : This function is only used to play the backup files on USB or CD/DVD device.



8.3.3 NET play mode

This mode allows you to remote control your DVR via Internet or Intranet. Press “ NET” to pop up the login window. Fill in Host Name, Host Port, User Name and Password of the DVR that you want remotely access and then press Login to enter the main page.

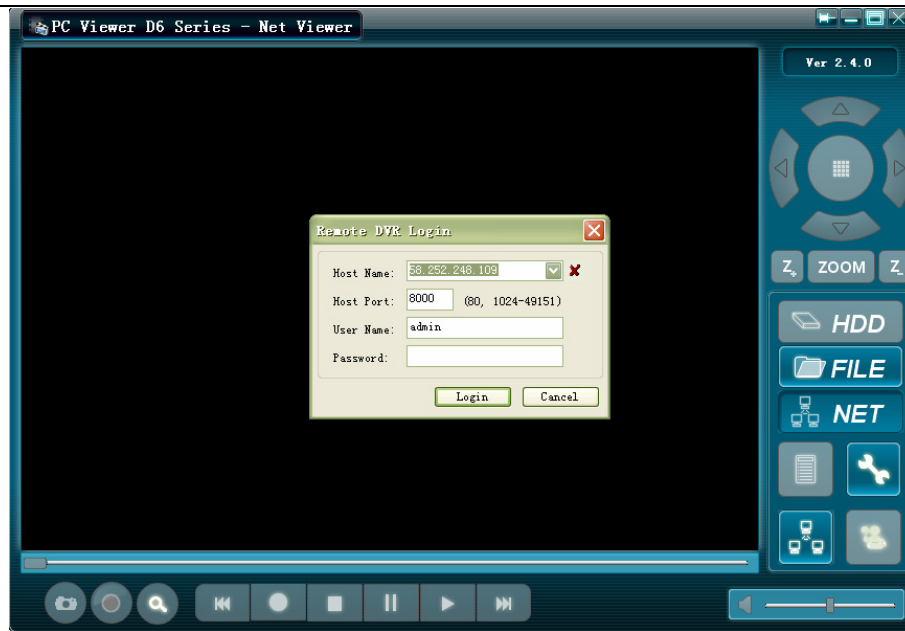

Chapter 9: Specification

4 / 9-Channel DVR

Items	Descriptions	
Video Standard	NTSC/PAL	
Video Input/Output	4 Channels/2 Channels , 9 Channels/1 Channel	
Audio Input/Output	2 Channels/2 Channels , 1 Channel/1 Channel	
Monitoring	Resolution	NTSC:720X480@30fps(Each Ch) PAL:720X576@25fps(Each Ch)
	Features	Full-D1 , 1-CH/4-CH/9-CH Display
Recording	Resolution	NTSC:720X240@60fps(4/9Ch.Total) PAL:720X288@50fps(4/9Ch.Total)
	Features	Variable Frame Rate/Variable QL per Channel
	Quality	4-Level(Highest, High, Normal, low)
Audio	ADPCM2 CODEC	
Video	MPEG-4	
Motion Detection	Settable Window/Level	
Microprocessor	32-bit RISC Processor	
Network Interface	TCP/IP(RJ45)	
Network Monitor	IE(Internet Explorer) PC Viewer Software	
PTZ Interface	RS-485	
USB Interface	USB 2.0	
VGA Output	Optional	

Chapter 10: Appendix

10.1 System connection diagram

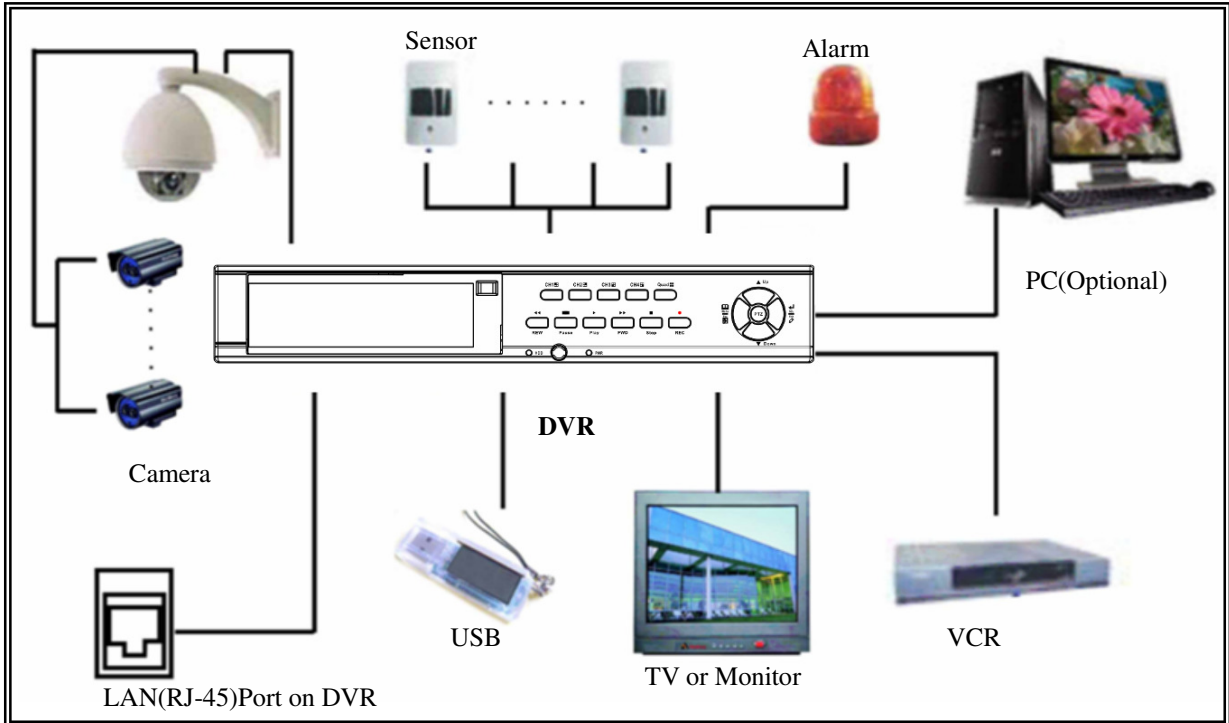

10.2 Accessories



Power Cord

Design may vary depending on country



Power Adaptor



User's Manual



Software CD



Remote Controller



USB Cable (For PC Backup Only)

China prints 2008.6

V1.0

The material in this document is the intellectual property of our department .

- No part of this manual may be reproduced, copied, translated, transmitted, or published in any form or by any means without our department prior written permission.
- Our products are under continual improvement and we reserve the right to make changes without notice. But no guarantee is given as to the correctness of its contents.
- We do not undertake any responsibility for the harms cause by using our product.
- The model of the products in the user's manual only f recognition, but these names also perhaps are belong to other company's registered trademark or the copyright.
- The product picture may differ from the actual product, only for your reference. The accessories will probably be different according to the different selling areas. For details of accessories, please refer to your local distributor.

Copyright reserved

Product Registration Card

Product Name: _____ Product Model NO.: _____
Date of Purchase: _____ Invoice NO.: _____
User Name : _____ FAX: _____
Telephone: _____
Address: _____
E-MAIL: _____
Franchiser or exclusive sales agent: _____

